

# Fan Clutch



**Shimahide**

U.S.A. Application

**CATALOG**

**2013**

# TOYOTA

\* USA MARKET \*

Car Model	Year	Displacement	Eng.Model	Water Pump No.	Fan Clutch No. (Replaced By)
4-Runner	(~02)	3378*Gas	5VZ-FE	Braket	16210-62011 (62030/08921-04950)
	(~02)	2693*Gas	3RZ-FE	16100-79445	16210-75040 (75060/0W010)
	(03~09)	3956*Gas	1GR-FE	16100-09471	16210-31020 (0P010)
	(10~)	3956*Gas	1GR-FE	16100-39545	16210-31030 (31040)
	(03~04)	4664*Gas	2UZ-FE	Braket	16210-50050 (50051/50080/50090)
	(05~09)	4664*Gas	2UZ-FE	Braket	16210-50100 (50101/50102)
FJ Cruiser	(07~09)	3956*Gas	1GR-FE	16100-09471	16210-31020 (0P010)
	(10~)	3956*Gas	1GR-FE	16100-39545	16210-31030 (31040)
Land Cruiser (200)	(~05)	4664*Gas	2UZ-FE	Braket	16210-50050 (50051/50080/50090)
	(06~07)	4664*Gas	2UZ-FE	Braket	16210-50100 (50101/50102)
	(08~)	5663*Gas	3UR-FE	Braket	16210-38070
Sequoia	(09~)	4608*Gas	1UR-FE	Braket	16210-38070
	(~05)	4664*Gas	2UZ-FE	Braket	16210-50050 (50051/50080/50090)
	(06~09)	4664*Gas	2UZ-FE	Braket	16210-50100 (50101/50102)
	(07~)	5663*Gas	3UR-FE	Braket	16210-38070
Tacoma	(~01)	2693*Gas	3RZ-FE	16100-79445	16210-75040 (75060/0W010)
	(02~)	2694*Gas	2TR-FE	16100-79445	16210-75100 (75110/75111)
	(~04)	3378*Gas	5VZ-FE	Braket	16210-62011 (62030/08921-04950)
	(05~09)	3956*Gas	1GR-FE	16100-09471	16210-31020 (0P010)
	(10~)	3956*Gas	1GR-FE	16100-39545	16210-31030 (31040)
Tundra	(~04)	3378*Gas	5VZ-FE	Braket	16210-62011 (62030/08921-04950)
	(05~06)	3956*Gas	1GR-FE	16100-09471	16210-31020 (0P010)
	(07~)	3956*Gas	1GR-FE	16100-39545	16210-31030
	(10~)	4608*Gas	1UR-FE	Braket	16210-38070
	(~04)	4664*Gas	2UZ-FE	Braket	16210-50050 (50051/50080/90)
	(05~06)	4664*Gas	2UZ-FE	Braket	16210-50100 (50101/50102)
	(07~)	5663*Gas	3UR-FE	Braket	16210-38070
GX470 (Lexus)	(~05)	4664*Gas	2UZ-FE	16100-59275	16210-50050 (50051/50080/50090)
	(06~09)	4664*Gas	2UZ-FE	16100-59275	16210-50100 (50101/50102)
GX460 (Lexus)	(07~)	4608*Gas	1UR-FE	16100-59275	16210-38070
LX470 (Lexus)	(~05)	4664*Gas	2UZ-FE	16100-59275	16210-50050 (50051/50080/50090)
	(06~07)	4664*Gas	2UZ-FE	16100-59275	16210-50100 (50101/50102)
LX570 (Lexus)	(07~)	5663*Gas	3UR-FE	16100-09490	16210-38070

## TOYOTA TYPE

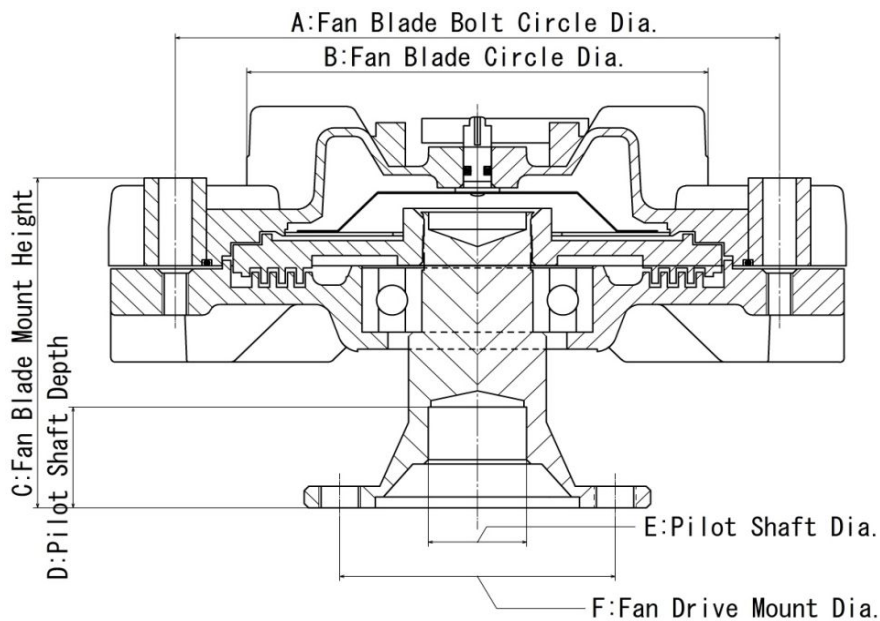

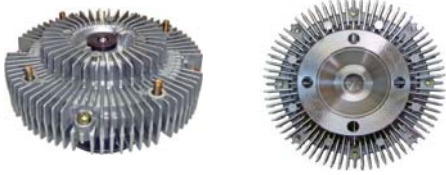
Fan Clutch No.			TOYOTA TYPE (Dimentions)
<b>16210-31020</b>  16210-0P010			<b>A=136.0</b> <b>B=103.8</b> <b>C=76.8</b> <b>D=23.5</b> <b>E=16.16</b> <b>F=62.0</b>
<b>16210-31030</b>  16210-31040			<b>A=136.0</b> <b>B=103.8</b> <b>C=88.4</b> <b>D=23.5</b> <b>E=16.16</b> <b>F=62.0</b>
<b>16210-38070</b>			<b>A=174.0</b> <b>B=153.8</b> <b>C=82.0</b> <b>D=17.0</b> <b>E=38.26</b> <b>F=68.0</b>
<b>16210-50050</b>  16210-50051 16210-50080 16210-50090			<b>A=136.0</b> <b>B=103.8</b> <b>C=65.4</b> <b>D=24.0</b> <b>E=16.16</b> <b>F=74.0</b>
<b>16210-50100</b>  16210-50101 16210-50102			<b>A=136.0</b> <b>B=103.8</b> <b>C=78.3</b> <b>D=24.0</b> <b>E=16.16</b> <b>F=74.0</b>
<b>16210-62030</b>  16210-62011 08921-04950			<b>A=136.0</b> <b>B=103.8</b> <b>C=67.0</b> <b>D=23.5</b> <b>E=16.16</b> <b>F=62.0</b>
<b>16210-75040</b>  16210-75060 16210-0W010			<b>A=136.0</b> <b>B=103.8</b> <b>C=68.7</b> <b>D=23.5</b> <b>E=16.16</b> <b>F=62.0</b>
<b>16210-75100</b>  16210-75110 16210-75111			<b>A=136.0</b> <b>B=103.8</b> <b>C=68.7</b> <b>D=23.5</b> <b>E=16.16</b> <b>F=62.0</b>

# NISSAN

\* USA MARKET \*

Car Model	Year	Displacement	Eng.Model	Water Pump No.	Fan Clutch No. (Replaced By)
Armada	(04-)	5552*Gas	VK56DE	Braket	21082-7S00A (7S001)
Frontier	(~04)	2389*Gas	KA24DE	21010-86G25	21082-86G00 (86G0A)
	(~04)	3274*Gas	VG33E	21010-4S126	21082-0W000 (0W00A/5S700)
	(05-)	2488*Gas	QR25DE	21010-EA010	21082-EA000 (EA00A)
	(05-)	3954*Gas	VQ40DE	Braket	21082-EA200
Pathfinder	(00-04)	3274*Gas	VG33E	21010-4S126	21082-0W000 (0W00A/5S700)
	(00-04)	3498-Gas	VQ35DE	Braket	21082-6P003 (6P00A)
	(05-)	3954*Gas	VQ40DE	Braket	21082-EA200
	(05-)	5552*Gas	VK56DE	Braket	21082-7S00A (7S001)
NV1500*NV2500	(12-)	3954*Gas	VQ40DE	Braket	21082-EA200
NV2500*NV3500	(10-)	5552*Gas	VK56DE	Braket	21082-7S00A (7S001)
Titan	(04-)	5552*Gas	VK56DE	Braket	21082-7S00A (7S001)
Xterra	(00-04)	2389*Gas	KA24DE	21010-86G25	21082-86G00 (86G0A)
	(05-)	3954*Gas	VQ40DE	Braket	21082-EA200

## NISSAN TYPE

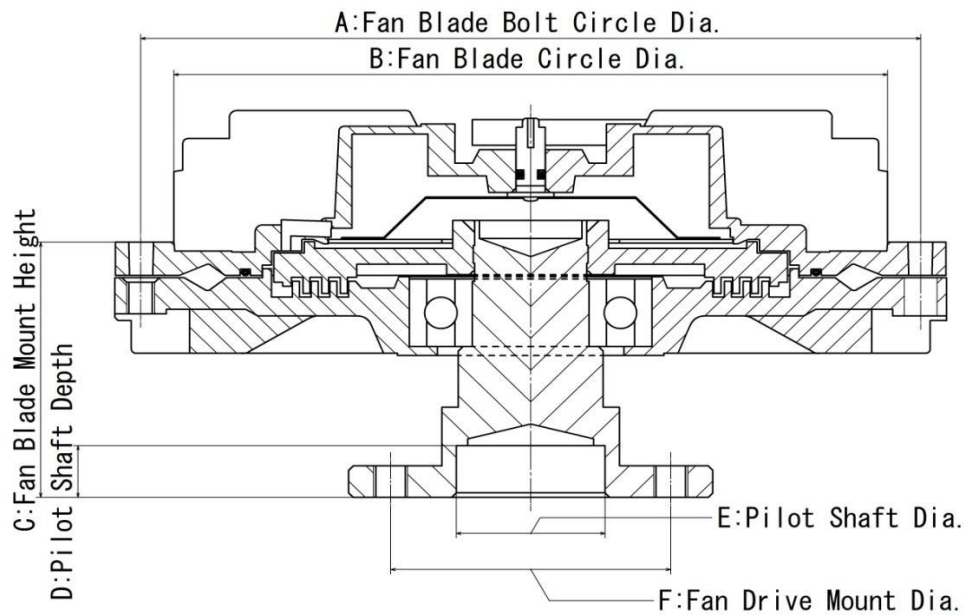

Fan Clutch No.			NISSAN TYPE (Dimensions)
<b>21082-0W000</b>  21082-0W00A 21082-5S700			<b>A=143.0</b> <b>B=128.8</b> <b>C=62.3</b> <b>D=11.5</b> <b>E=31.96</b> <b>F=60.0</b>
<b>21082-6P003</b>  21082-6P00A			<b>A=153.0</b> <b>B=135.8</b> <b>C=60.0</b> <b>D=11.5</b> <b>E=31.96</b> <b>F=60.0</b>
<b>21082-7S00A</b>  21082-7S001			<b>A=167.0</b> <b>B=152.8</b> <b>C=56.3</b> <b>D=11.5</b> <b>E=31.96</b> <b>F=60.0</b>
<b>21082-86G00</b>  21082-86G0A			<b>A=134.0</b> <b>B=119.8</b> <b>C=45.0</b> <b>D=11.5</b> <b>E=31.96</b> <b>F=60.0</b>
<b>21082-EA000</b>  21082-EA00A			<b>A=153.0</b> <b>B=136.8</b> <b>C=67.1</b> <b>D=11.5</b> <b>E=31.96</b> <b>F=60.0</b>
<b>21082-EA200</b>			<b>A=164.0</b> <b>B=144.8</b> <b>C=67.3</b> <b>D=11.5</b> <b>E=31.96</b> <b>F=60.0</b>

# MITSUBISHI \* USA MARKET \*





Car Model	Year	Displacement	Eng.Model	Water Pump No.	Fan Clutch No. (Replaced By)
Montero	(97-00)	3497*Gas	6G74	MD979171	MD356867 (MN176301)
	(01-06)	3827*Gas	6G75	MD979171	MD356867 (MN176301)
Montero Sports	(97-04)	2972*Gas	6G72	MD356876	MD334660 (MD335271)(MN119786)
	(97-04)	3500*Gas	6G74	MD356876	MD334660 (MD335271)(MN119786)

Fan Clutch No.		Dimensions
<b>MD334660</b>		<b>A=153.0</b> <b>B=136.8</b> <b>C=58.0</b> <b>D=10.0</b> <b>E=24.16</b> <b>F=56.0</b>
MD335271 MN119786		
<b>MD356867</b>		<b>A=177.0</b> <b>B=159.8</b> <b>C=73.7</b> <b>D=12.0</b> <b>E=24.16</b> <b>F=56.0</b>
MN176301		

# ISUZU

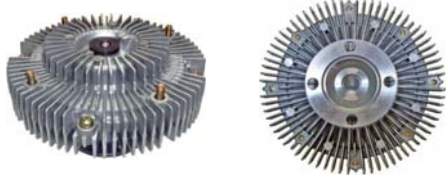
\* USA MARKET \*

Car Model	Year	Displacement	Eng.Model	Water Pump No.	Fan Clutch No. (Replaced By)
Axiom	(02-04)	3500*Gas	6VE1	8-97167-554-0	8-97349-761-0 (8-97329-954-0)
N-Series	(04-10)	5193*Diesel	4HK1-TC	8-97363-478-0	8-98019-743-0
	(11-~)	5193*Diesel	4HK1-TCN	8-98004-292-2	8-98024-684-0(8-97382-603-1 w/o F.B.)
Rodeo	(98-02)	3200*Gas	6VD1		8-97172-200-2(8-97130-362-1)(8-97172-200-0/1)
	(03-04)	3200*Gas	6VD1	8-97167-554-0	8-97349-761-0 (8-97329-954-0)

Fan Clutch No.		Dimensions
<b>8-97172-200-2</b>		A=136.0 B=103.8 C=67.0 D=23.5 E=16.16 F=62.0
8-97130-362-1 8-97172-200-0/1		
<b>8-97349-761-0</b>		A=164.0 B=144.8 C=63.1 D=23.5 E=16.16 F=62.0
8-97329-954-0		
<b>8-98019-743-0</b>		A=177.0 B=159.8 C=65.5 D=7.0 E=22.5 F=130.0
8-98024-684-0		
<b>8-98024-684-0</b>		A=177.0 B=159.8 C=93.4 D=15.5 E=32.16 F=60.0
8-97382-603-1 w/o F.B.		

# SUZUKI

\* USA MARKET \*

Car Model	Year	Displacement	Eng.Model	Water Pump No.	Fan Clutch No. (Replaced By)
XL7	(01-03)	2736*Gas	H27A	17400-85830	17120-52D00 (52D01) 17120-52D10
	(04-06)	2736*Gas	H27A	17400-85830	
Side-kick	(90-98)	1590*Gas	G16B	17400-61820	17120-57B00 (57B01)
Grand Vitara	(00-05)	2493*Gas	H25A	17400-85830	17120-77E00 (01/02/05/07)

Fan Clutch No.			Dimensions
<b>17120-52D00</b>			A=153.0 B=136.8 C=57.5 D=17.5 E=16.16 F=50.0
17120-52D01			
<b>17120-52D10</b>			A=164.0 B=144.8 C=60.9 D=17.5 E=16.16 F=50.0
			
<b>17120-57B00</b>			A=98.0 B=81.8 C=51.0 D=6.5 E=24.16 F=40.0
17120-57B01			
<b>17120-77E00</b>			A=153.0 B=136.8 C=57.5 D=17.5 E=16.16 F=50.0
17120-77E01/02 17120-77E05/07			



**Shimahide**

MADE IN JAPAN

[www.shimahide.jp](http://www.shimahide.jp)

